

Article number: 01020451

Description: Retaining ring J28 DIN472  
Stainless 411

## Measures

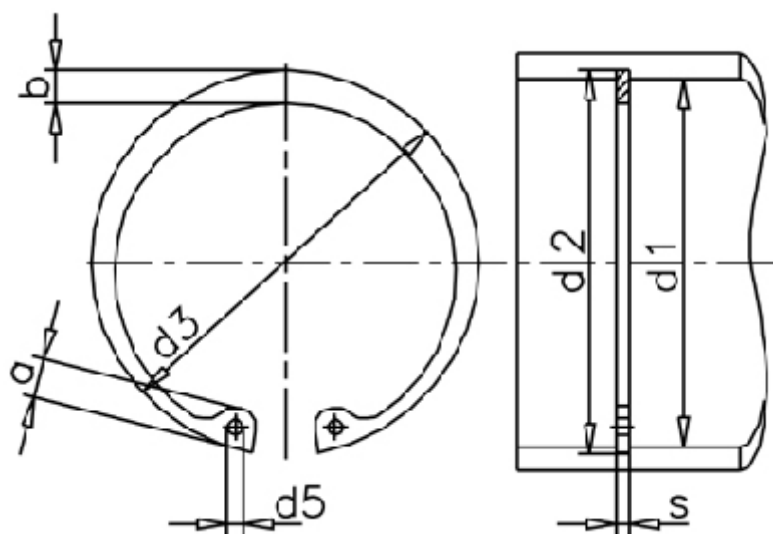

a max	= 4.8	FN kN	= 10.50	t	= 0.70
AN mm <sup>2</sup>	= 63.1	FRg kN	= 4.5	tol	= +0,21
b	= 2.9	FR kN	= 13.3	tol	= +0,50-0,25
d1	= 28	g	= 1.0	tol	= -0.06
d2	= 29.4	K kN-mm	= 26.3	Tong	= ZGJ-2
d3	= 30.10	m min	= 1.30	Weight kg/1000	= 1.80
d5 min	= 2.0	Nominal drive	= 2.1		
Description = J 28		s	= 1.20		